

# DiGi Module XT Globe

# Dimensions

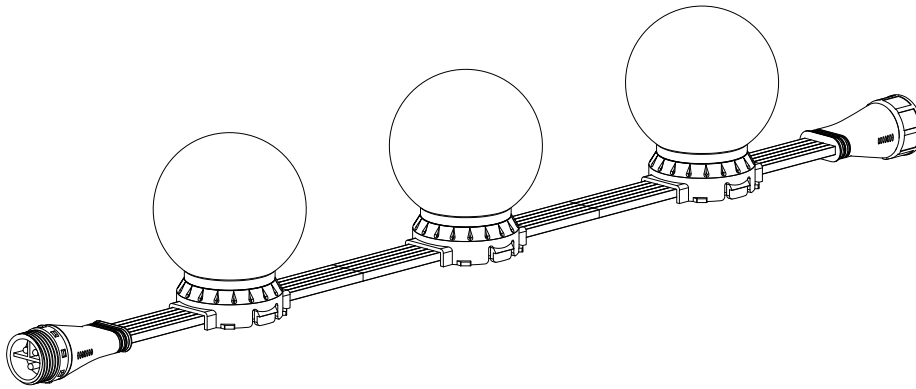

M20 Male 3Pin  
Input connector

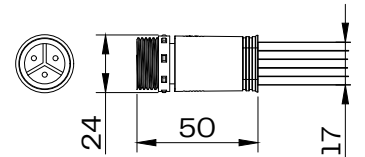

M20 Female 3Pin  
Input connector

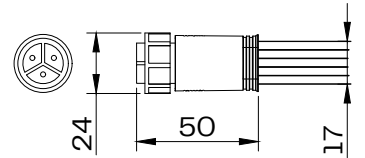

**Connector**  
SCALE 1:3

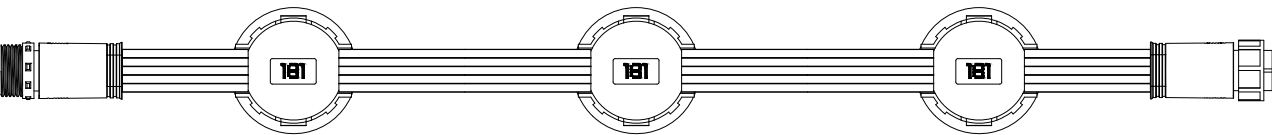
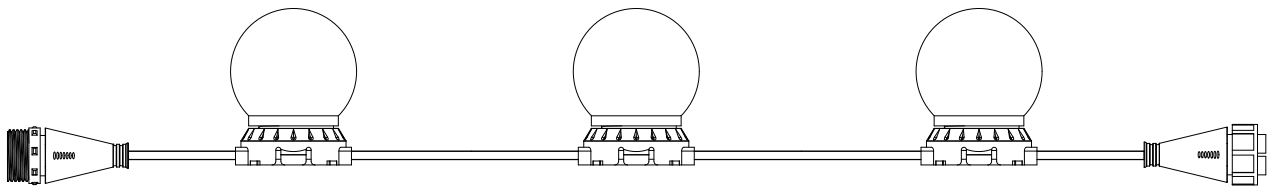
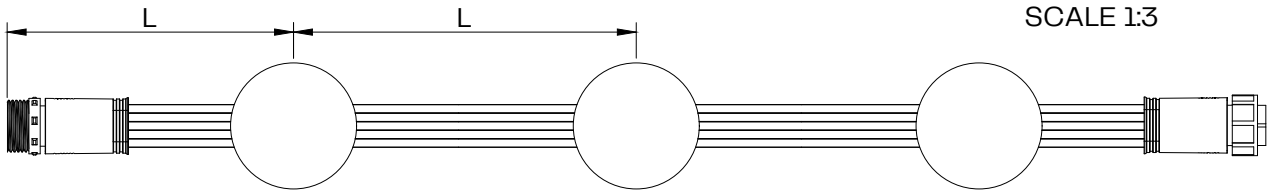

**XT Globe**  
SCALE 1:3

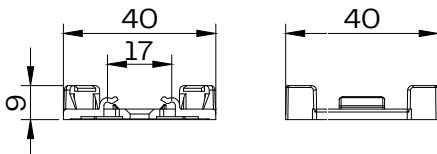
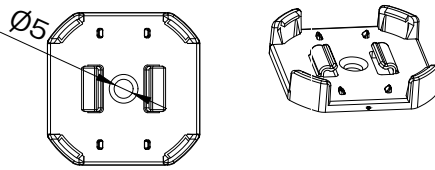

**Mounting clip**  
SCALE 1:2

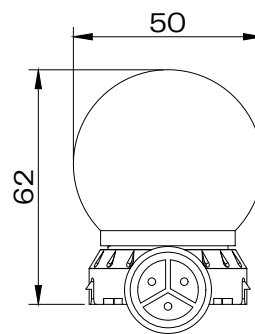

**Side view**  
SCALE 1:2

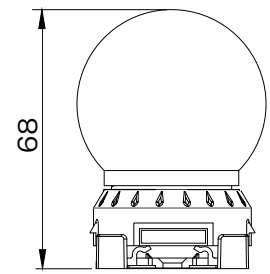

**Side view incl. clip**  
SCALE 1:2

## Disclaimer

Due to the technical evolution and improvement of our products, the data provided in this document may be updated on a regular basis, and as such, confirmation of this information is strongly recommended prior to the order process. OneEightyOne is not responsible for any discrepancies in this document following changes in our products. We reserve the right to make technical changes to our products and to change information, at its sole discretion, without notice.